

seko

Solutions for **Cleaning & Hygiene**



Your Choice,
Our Commitment

Content

Introduction	page 04
Kitchen Hygiene	page 06
• Peristaltic Pumps	
• Double & Triple systems	
• Timed Dosing	
Laundry	page 20
• OPL Basic, Smart System	
• Wash System	
Surface Cleaning	page 34
• Dilution Control	
• Cleaning and Disinfection	
• Foaming Systems	
• Spray Systems	
• Refill Range	
Specialty	page 52
Additional Information	page 58



A Worldwide Group at your service

Globally Present, Locally Active

Our Global presence ensures that we can support our customers wherever they are. Supported by teams in over 20 countries, as well as by our accredited partner distributor network, we ensure professional, local customer support in over 120 countries, with the added benefit of rapid delivery of goods to meet your needs.

All this backed up and supported by a world-class team of technical customer service, able to provide all the back up or technical support needed. With ISO Certified production sites in Europe, the Americas and Asia, we are close to our customers and fully compliant with all local norms both in terms of our product designs as well as our production facilities.

How SEKO works for You

From the spark of an idea, through to the delivery of a solution, SEKO is with you all the way

SEKO supports its customers in every phase of a project, from the inception of an idea or request, through design and testing to launch and installation. Our in-house research, design and development teams work closely with the local teams, drawing on customer and market inputs. Then using state-of-the-art technologies to optimize costs and using our own specifically designed test benches to ensure rigorous, robust testing, we ensure a quality solution is delivered quickly to market.

No matter which processes and applications are planned SEKO has a solution in the cleaning and hygiene of kitchens and laundries and surfaces of all types in applications like Offices and Restaurants, Hospitals and Hotels, Retailers and Schools, Car Washes and Swimming Pools, Cooling Towers, Energy, Food & Beverage, Water & Gas Utilities Potable and Waste Water Treatment.

1 Partnership Philosophy

Being a privately-owned business means that we are here for the long term and can plan projects with and for our customers, where both parties benefit. It means we can rapidly take decisions to invest our resources to ensure our optimum solutions are delivered.

2 Your Business, Our Solutions

Our extensive product range represents a unique combination of design, development and implementation know how. With a wide and ever evolving range of products and ancillaries, we can offer specific and comprehensive solutions for a variety of industrial applications. Our solutions are conceived to fit seamlessly into your operation, optimizing the processes and applications.

3 Uniquely Positioned

SEKO's 3 business units, Cleaning & Hygiene, Water & Industry and Industrial Processes puts us in a unique position to be able to respond to the widest range of business needs, with a broad range that allows you, the customer, to deal with just one company, simple.

Cleaning and Hygiene

An ever-evolving set of solutions for your environment

SEKO has always supported businesses facing the commercial challenges that arise from having to ensure the cleanest most hygienic premises, whilst driving costs down and minimizing environmental impact. Today, it has built a worldwide reputation as a leader in the world of Cleaning and Hygiene Dosing and Dilution Solutions. Exploiting our market experience, we design, develop, test and manufacture designs that ensure all our solutions and systems deliver:

Precision and Consistency

Maximizing cost control for chemical dosing, or ensuring the right dilution rate is used, requires advanced technology, impervious to fluctuations in water pressure, to guarantee an effective result, in turn providing the security for a given business brand.

Ease of Use and Installation

As a global company, we are attuned to the differing needs of individual markets. This is why, when we design a new product, we ensure that installation is simple, that we use uniform programming language solutions that are intuitive and easy to understand, in whatever language you speak.

Safety and Reliability

The safety of customers and operators is paramount, requiring the very best in terms of design and features. SEKO's range provides this security. From the locking mechanisms of our SekureDose range through to the IP65 and NEXA 4X enclosures of our warewash systems, safety is at the forefront of our design ethos. Reliability drives good safety, and all SEKO's products are fully tested prior to leaving our warehouse.

Operational Efficiency

Running a business is about making money. To do this, SEKO plays its part. From the affordability of the range of solutions, through to thoughtful design elements like the semi flat pack design of Sekure cabinets to state of the art design and squeeze tube technology, that improves the lifetime of motors and tubes alike, all aimed at reducing operating costs.





Kitchen Hygiene

SEKO's Solutions designed with the Kitchen in Mind

Working alongside Global machine and chemical manufacturers and food service operators SEKO has developed a high-quality range of pumps, designed to keep equipment performing brilliantly. From peristaltic pump systems, designed to deliver precise quantities of chemical, to robust and highly efficient dosing systems for enzyme drain cleaning solutions, we can help keep a food service operation running cleanly and smoothly.

Glasswashers

- Peristaltic dosing pumps

Door type dishwashers

- Peristaltic dosing pumps
- Double/Triple Dosing systems

Conveyor dishwashers

- Peristaltic dosing pumps
- Double/Triple Dosing systems

Timed Control

- Digital or Analog programmer

WareBasic

Peristaltic Pump

SEKO's WareBasic peristaltic range offers reliable robust and affordable dosing solutions for glasswash machines, door type and conveyor warewash machines.

Offering simple installation and connection, there are models available for both dry and liquid detergents. Safety and reliability is assured thanks to polypropylene enclosures, meeting NEMA 4X classification while ease of use and low operating costs feature across the range.



WareBasic PR 7

Detergent peristaltic pump with analog speed adjustment



WareBasic PR 1

Rinse-Aid or Sanitizer peristaltic pump with analog speed adjustment



WareBasic PRT6

Probeless, fixed speed peristaltic pump with analog adjustment for detergent initial charge and make up charge

Microprocessor technology

The entire range of WareBasic dispensers utilises microprocessor technology for consistent, precise and reliable control.

SekoFlex and SekoBril squeeze tubes

SekoFlex and SekoBril squeeze tubes are made to maintain a constant ratio of internal to external diameter along the tube's entire length and trimmers for setting chemical concentration and dosing modes.

Features

- Precise programming of speed, time and conductivity value with latest generation trimmers and microprocessor technology
- Long lifetime of squeeze tube and motor due state of the art design and squeeze tube technology
- NEMA 4X (IP 65) enclosure for optimum water resistance. SEKO's material and construction offers excellent resistance to impact and chemical exposure
- Electrical class 2, no ground wire needed

WareBasic

Peristaltic Pump



WareBasic PA 9

Fixed speed peristaltic pump with analog dosing adjustment by conductivity probe



WareBasic PA D

Fixed speed with analog dosing adjustment by conductivity probe

WareBasic PR 7

Power Supply: automatic switching from 20 - 240 Vac, 50 - 60 Hz

Power Consumption: 3.5 W

Flow Rate: max 4.1 oz/min

Pressure: max 1.5 psi

Squeeze Tube: SekoFlex

WareBasic PR 1

Power Supply: 20 - 240 Vac, 50 - 60 Hz

Power Consumption: 3.5 W

Flow Rate: max 0.6 oz/min

Pressure: max 45 psi

Squeeze Tube: SekoBril

WareBasic PRT6

Power Supply: 100 - 240 Vac, 50 - 60 Hz

Power Consumption: 3.5 W

Initial Charge time: 18 - 180 sec

Make Up Charge time: 2 - 15 sec

Flow Rate: max 3.5 oz/min

Pressure: max 1.5 psi

Squeeze Tube: SekoFlex

WareBasic PA 9

Power Supply: 100 - 240 Vac, 50 - 60 Hz

Power Consumption: 3.5 W

Flow Rate: max 5.3 oz/min

Pressure: max 1.5 psi

Squeeze Tube: SekoFlex

WareBasic PA D

Power Supply: 100 - 240 Vac, 50 - 60 Hz

Power Consumption: 7 W

WareMax

Double and triple systems

WareMax is a range of dispensers that offers accurate, state of the art, microprocessor controlled dispensing technology all in one. The range offers automatic compact liquid or dry detergent in probe or probe less mode dispensers. Designed specifically for large conveyor and door type warewash machines, it effectively eliminates all manual operations. SEKO's extensive experience in dosing systems ensures that quick and easy installation is a priority.



WareMax LL

1 detergent pump, 1 rinse-aid pump

- Easy installation and intuitive programming
- Micro switches and trimmers for manual setting of chemical concentration and dosing modes.
- Compression fittings supplied for all plumbing and tubing connections
- Mounts easily to the wall thanks to the mounting bracket
- WareMax automatically accepts detergent / rinse signals from 100 to 240 Vac, no other power source required
- Motor speed control compensates for loss of speed, protecting against motor breakage



WareMax LLL

1 detergent pump, 1 rinse aid pump, 1 sanitizer pump

Features

- Precise programming of speed, time and conductivity value with latest generation trimmers and microprocessor technology
- Long lifetime of squeeze tube and motor due state of the art design and squeeze tube technology
- Nema 4 (IP 65) enclosure for optimum water resistance. SEKO's material and construction offers excellent resistance to impact and chemical exposure
- Electrical class 2, no ground wire needed

WareMax

Double and triple systems



WareMax DL

1 solenoid valve for powder detergent, 1 rinse aid pump

WareMax DLL

1 solenoid valve for powder detergent, 1 rinse-aid pump, 1 sanitizer pump

WareMax LL

Detergent Pump

Flow rate:	max 4.7 oz/min
Pressure:	max 1.5 psi
Squeeze tube:	SekoFlex

Rinse Aid Pump

Flow rate:	max 0.7 oz/min
Pressure:	max 45 psi
Squeeze tube:	SekoFlex

Power Supply:	100 - 240 Vac, 50 - 60 Hz
---------------	---------------------------

WareMax DL

Solenoid valve brass:	24 Vdc
-----------------------	--------

Flow rate:	max 4.7 oz/min
------------	----------------

Rinse Aid Pump

Flow rate:	max 0.7 oz/min
------------	----------------

Pressure:	max 45 psi
-----------	------------

Squeeze tube:	SekoFlex
---------------	----------

Power Supply:	100 - 240 Vac, 50 - 60 Hz
---------------	---------------------------

WareMax LLL

Detergent Pump

Flow rate:	max 4.7 oz/min
Pressure:	max 1.5 psi
Squeeze tube:	SekoBril

Rinse Aid and Sanitizer Pump

Flow rate:	max 0.7 oz/min
Pressure:	max 45 psi
Squeeze tube:	SekoBril

Power Supply:	100 - 240 Vac, 50 - 60 Hz
---------------	---------------------------

WareMax DLL

Solenoid valve brass:	24 Vdc
-----------------------	--------

Flow rate:	max 4.7 oz/min
------------	----------------

Rinse Aid and Sanitizer Pump

Flow rate:	max 0.7 oz/min
------------	----------------

Pressure:	max 45 psi
-----------	------------

Squeeze tube:	SekoFlex
---------------	----------

Power Supply:	100 - 240 Vac, 50 - 60 Hz
---------------	---------------------------

WareMini

Compact detergent and rinse-aid dispensers

It's not everyday that high performance and simplicity in use can be found in a single package that's also very affordable. SEKO's new WareMini range offers digital technology enclosed in a small attractive double pump system, pre-cabled and preset. The perfect recipe for ideal warewash dosing applications. Effortlessly delivering outstanding results, this WareMini range provides the perfect balance between value and benefits.



Features

- Pre-cabled system reduces installation time
- Switchable power supply from 100 to 240 Vac helps reduce inventory stock
- No additional power source required, accepts signals from 100 to 240 Vac
- Water resistant using Nema 4X enclosures gives high degree of protection
- Extended conductivity range 200 μ S to 10mS with air reading capability to avoid unwanted dosages
- Optimum precision of the set point

Digital Models Only

- Easy, fast and preset programming guarantees minimum setup time
- Probe and probe-less mode maximum versatility
- Digital LED display easy to read even in poor light conditions

WashMini

Power supply: 100 - 240 Vac, 50 - 60 Hz

Detergent Flow Rate: 0.7 - 4.2 oz/min at 1.5 psi

Rinse Aid Flow Rate: 0.1 - 0.7 oz/min at 45 psi

Sanitizer Flow Rate: 0.1 - 0.7 oz/min at 45 psi

Drain Series

Timed Dosing Systems

SEKO offers the industry's leading drain enzyme dosing system. Known for reliability and durability, the Drain Series systems are used primarily for grease trap maintenance but are suitable for many other applications, where intermittent, timed dosing operations are needed. The Drain Series systems automatically meter exact amounts of chemical anytime of the day or night as desired, minimizing waste.



Drain Plus
Fully programmable



Drain Battery
Compact and easy dosing



Drain Mini
Fully programmable

Features

- Delivery of a single chemical at predetermined timed intervals
- Up to 48 programmable events per day
- Quick and easy installation
- Low maintenance, robust design
- User friendly programming speeds operations
- Extended battery life

Drain Plus

Programmable runtime - Minimum period of 1 second

Flow rate:	Adjustable 0.07 - 7 oz/min
Timer:	Complete digital control
Max Qty/24 hrs:	78 Gallons (max flow rate)
Power Supply:	Universal 100 - 240 Vac
No. of Feed Times/hrs max:	48 on-times/24 hrs

Drain Battery

Programmable runtime - Minimum period of 1 minute

Flow rate:	3.5 oz/min
Timer:	Digital
Max Qty/24 hrs:	40 Gallons
Power Supply:	12 Vdc
No. of Feed Times/hrs max:	17 on-times/24 hr

Drain Mini

Programmable runtime - Minimum period of 1 minute

Flow rate:	4 oz/min
Timer:	Complete digital control
Max Qty/24 hrs:	45 Gallons
Power Supply:	Universal 100 - 240Vac
No. of Feed Times/hrs max:	24 on-times/24 hr

D3000

All Mode Dosing

The D3000 is an extremely versatile and flexible liquid dispensing system for machine warewashing. It can dose detergent based on conductivity (probe mode), pump run time (timed mode) or speed mode (proportional) both of which are probe less. The D3000 has unique features that provide superior warewashing results with tight control of product usage and is designed to reduce installation and maintenance time.

Superior results

- Self-learning detergent feed algorithm maintains detergent set point
- PulseDrive conductivity measurement circuit resists effects of probe scaling
- Temperature compensation option
- Initial detergent charge triggered by rinse duration provides good results in probeless mode
- Variable rinse speed and timed options provide spot free dishware
- Low level alarm input option ensures customer promptly replaces empty product containers
- Basic data logging of racks and drains (conductivity mode)

Ease of installation and maintenance

- Easy set up with Uniview programmer
- Optional potentiometer controls provide flexibility
- Individual product prime switches
- Indicator for power dosing and depletion
- Standard SnapHead pump cartridges

D3000

Detergent:	15 - 150 ml/min, 0.5 - 5.1 oz/min
Rinse:	4 - 18 ml/min, 0.14 - 0.6 oz/min
Conductivity probe:	K = 0.4
Conductivity range:	660 - 12,800 μ S at 25°C
Voltage and current:	24 Vac, 1 Amp max
Programming controls:	Uniview or potentiometers
Data logging:	0 - 2,400,000 racks



Features

- Flexible Configuration
- Ease of Installation
- Simple to Maintain
- Easy to Program
- Optional third pump

Sierra

All Mode Dosing with advanced functions

Sierra is a multi-product chemical dispensing system for use in machine warewash applications. The advanced features include rack counting, pump and dishmachine runtime, audible alarms, multiple languages and water resistance. Sierra's patented Virtual Clean Probe™ (VCP) guarantees fewer service calls, better performance and eliminates wasted chemical due to incorrect conductivity readings.



- Comes complete with installation kit, rinse injector and mounting bracket.
- Automatic switching from 100 to 240 Vac protects from damaging power fluctuations
- Installation requires less than 1 hour
- Fast programming thanks to intuitive text menus.
- Can be installed with or without a probe in any door or conveyor warewash system

Sierra

Power Configurations: 100 - 240 Vac, 50-60 Hz, 0.3 Amp

Pump Tubing: Detergent: Norprene
Rinse: BiWall
Sanitizer: Norprene

Detergent Flow Rate: 0.24 - 4.8 oz/min (7 - 140 ml/min)

Rinse Flow Rate: 0.025 - 0.5 oz/min (0.75 - 15 ml/min)

Sanitizer Flow Rate: 0.01 - 2 oz/min (3 - 60 ml/min)

Wash & Rinse Voltage: 24 - 240 Vac
30 - 100 Vdc

Features

- Easy setup using text-based programming menus
- Increased hygiene control - includes alarms for Dirty Washwater, Low Product, Out of Product
- Reduces detergent overuse and probe maintenance with VCP
- Manages profitability and efficiency with datalogging of rack count, pump and warewasher runtime
- Simplified maintenance with patented SnapHead™ pump

Tahoe

Time and Speed Dosing

Tahoe is an economical, user-friendly dispensing system for warewash and other chemical dosing applications. It features a rugged, water-resistant enclosure, as well as highly efficient circuitry. The 100 Series SnapHead™ pump cartridge provides excellent tube life, and is easy to remove and replace. Modular design allows several Tahoes to fit together for multi-pump applications and a sliding door hides the adjustments from view.

Tahoe

Pump:	24 Vdc
Maximum Pressure:	10 psi/0.7 bar/69 kPa detergent, 30 psi/2.1 bar/200 kPa rinse
Detergent Flow Rate:	110 ml/min nominal, not to run more than 15 out of 30 minutes
Rinse Flow Rate:	16 ml/min nominal, unlimited continuous run
Input voltage:	200 - 240 Vac, 50/60 Hz, 0.1 Amp 100 - 120 Vac, 50/60 Hz, 0.2 Amp



Features

- Easy setup
- Low maintenance
- Speed, time, and initial charge in one SKU
- Modular
- Prime button
- 115 and 230 Vac inputs
- Remote push-button option

DR-2000

Timed Chemical Feed System

DR-2000 is ideally suited for applications such as: drains, cooling towers, boilers, spas, pools and fountains.

Easy to program

- DR-2000's unique 7-day clock can program dosing events that occur one day per week, all weekdays, all weekends or every day
- Program up to 24 events with variable run times from 1 second to 20 minutes
- Tamper-prevention programming
- Simple erase procedure clears unwanted events
- Backup power source

DR-2000

Power Configurations: 115 - 230 Vac, 50 - 60 Hz
4 D-Cell Battery

Pump: Peristaltic, self-priming,
self-checking 6 volt DC

Speed: 100 rpm

Flow Rate: 5 oz/min (148 ml/min)



Features

- Easy setup, programming and maintenance mean you spend less time in the field
- Cost effective, even for small accounts
- Mounting bracket reduces installation time
- Water resistance ensures safety
- Battery pack allows you to install where line power is not available

Encapsulator

Dry Detergent Reservoir Sink Filling

The Encapsulator is a simple, reliable method of dispensing dry and solid products into sinks. Unreliable timers and hand pumps are replaced with a simple 1/4 turn valve that fills the sink and doses chemical concurrently. Solution strength is set with an internal adjustment.

Theory of operation

When the fill valve is turned on, water is sprayed up into the capsule for product washout. Gravity dis-charges the concentrated solution down the primary delivery tube. Bypass water in the secondary delivery tube dilutes the concentrate in the mixing zone. The final solution flows into the sink ready for use. Product concentrations can easily be adjusted by increasing or decreasing the amount of bypass water.

For solid product applications with chemical bottles that have screens on the end, we recommend using Encapsulator Plus with the 84° nozzle. To handle different product formulations, nozzles are available with different spray patterns and flow rates.

Features

- Requires less maintenance than eductors or battery-powered systems
- Fast installation with integral vacuum breaker
- Extraordinarily easy to use. Simply turn a knob to fill sink with water and an exact concentration of chemical
- No chemical containers on the floor or under the sink
- No-spill product containers are easier to handle and store than liquid buckets
- Safety shield covers nozzle as soon as product is removed



Encapsulator

Dimensions: H 18.5" x W 10.5" x D 8"

Weight: 4.7 lb

Incoming Water Temp: 100 - 130°F (38 - 54°C)

Minimum Pressure: 20 psi (1.4 bar)

Maximum Pressure: 80 psi (5.5 bar)

Maximum Flow Rate: 4.5 gpm (17.0 l/min)

Spray Nozzle Options: Flow at 50 psi, 3.4 bar

Encapsulator Plus

Dry Detergent Reservoir Sink Filling

The Encapsulator Plus dispenses a ready-to-use mix of chemical product and water to pot-and-pan sink or pre-soak applications. It operates from a single manual valve and delivers a consistent product mixture.

Encapsulator Plus

Dimensions:	H 18.5" x W 10.5" x D 8"
Weight:	4.7 lb
Incoming Water Temp:	100 - 130°F (38 - 54°C)
Minimum Pressure:	20 psi (1.4 bar)
Maximum Pressure:	80 psi (5.5 bar)
Maximum Flow Rate:	4.5 gpm (17.0 l/min)
Misting Nozzle:	0.052 gpm (0.20 l/min) at 30 psi (2.1 bar)
Slow Feed:	0.052 gpm (0.20 l/min) at 30 psi (2.1 bar)



Applications

The dispenser is specifically for pot-and-pan sinks (Solid model) or encapsulated powder products (Powder model). Different types of products require different spray nozzle assemblies.

W-6000

Dry Detergent Reservoir

W-6000 Solid Master is a rugged, glass-filled polypropylene reservoir for dispensing encapsulated cleaning products. It accepts any typical 6 inch diameter plastic bottle. The open top design allows the tallest bottles to fit easily, and a strategically located spray nozzle assures total product wash-out.

- Incorporates a spring-loaded spray deflector prevents the operator from being sprayed when changing bottles
- Water spray contacts the contents and dissolves chemical; solution drains from bottom of the bowl

Features

- Fast installation
- Positive mechanical deflector prevents water spray during bottle changing
- Maximum wash-out for cost effective dispensing
- Durable, glass filled polypropylene construction



W-6000

Dimensions:	H 9.5" x W 7" x D 9.6"
Weight:	3 lb
Housing:	Glass-filled polypropylene

Singleshot

Microprocessor-Controlled Dosing System

Simple, Low-Cost Dosing for Laundry and Warewash applications.

SingleShot is a microprocessor-controlled chemical injection device for accurate, on-demand dosing of applications, including over-the-sink pot and pan and top-load laundry machine dosing.

- Features programmable delay, dose and lockout times of 0 to 20 mins each
- Suitable for top-loading laundry applications
- Programmable dose time allows for timed or volumetric dosing
- Lockout time can be programmed to protect against repeat dosing
- Available in 115 Vac or battery power, comes with low-battery indicator

DR-2000

Power Configurations: 115 Vac, 50/60 Hz
4 D-Cell Battery

Pump: Peristaltic, self-priming,
self-checking 6 volt DC

Speed: 100 rpm - line power
80 rpm - batteries

Flow Rate: 5 oz (148ml)/min - line power
4 oz (118ml)/min - batteries



Features

- Incredibly easy to program
- Can be equipped with an external trigger for remote dosing
- Easily automates top-loading laundry machine dosing
- Programmable lockout prevents accidental repeat dosing
- Water-resistant enclosure



Laundry

SEKO Solutions for a Smarter Laundry

Running and supplying on-premise or commercial laundries is a complex business and accurate, reliable dosing management is one aspect that needs to be dependable. SEKO has a range of liquid single and multi-machine units to suit most applications including the provision for remote access and data management of a site operation. SEKO's laundry dosing systems, regardless of the range chosen, offer the most reliable, easy-to-use and resilient models on the market today.

OPL machines

- Peristaltic dosing pumps
- Double/Triple Dosing systems

Commercial machines

- Double/Triple Dosing systems
- Multiple dosing systems

Industrial machines

- Double dosing systems
- Multiple dosing systems

Tunnel machines

- Dosing systems

Multi-washer machines

- Centralized peristaltic multiwasher system
- Centralized pneumatic multi-washer system
- Multi-tunnel system with PLC
- Relay systems for tunnel



OplBasic

Effective systems for On Premise Laundry

Built to meet the simplest needs of an on-premise laundry, yet featuring SEKO's design know how, OplBasic is easy to install, straightforward to use and has a low maintenance requirement. All of this in a design that ensures user safety and equipment reliability. The OplBasic Series offers a wide range of single and/or two product timed systems for liquid and dry product applications. Chemical dosing is activated automatically by a signal from the washer or by manually pressing the membrane switch located on the front of the unit.



OplBasic L

Dosing system with a peristaltic pump



OplBasic D

Dosing system with a solenoid valve



OplBasic LL

Dosing system with double peristaltic pump

Features

- Dip switches, trimmers and jumpers make calibration and programming quick and easy
- Front cover opens to 90° degrees for easy access to connections
- Prime switches for each product
- Easy Installation - Simply connect the tubing and power supply
- Easily mounted and removed with built in mounting brackets
- No special tools required
- All settings are made inside the cabinet to discourage tampering
- Optional remote manual switch also available

Dosing time

Accepts program run time 0 to 10 minutes. Easy calibration method of programming.

Lock out time

Prevents repeat dispensing of product from 0 to 75 minutes with dip switch settings. When the lock out time expires, the pump or solenoid valve will restart, if signalled.

Delay time

Using an internal trimmer, delay the start of the pump from 0 to 5 minutes. When the OplBasic receives a signal, dispensing won't begin until after the programmed delay time.

Alarms

Optional: LED and buzzer signals an empty product warning.

OplBasic

Effective systems for On Premise Laundry



OplBasic DD

Dosing system with double solenoid valves

OplBasic DL

Dosing system with peristaltic pump and solenoid valve

OplBasic L

Power supply:	115/208/230 Vac, 50 - 60 Hz
Power consumption:	4.5 W
Max flow rate:	10 oz/min
Squeeze tube:	SekoFlex

OplBasic D

Power supply:	115/208/230 Vac, 50 - 60 Hz
Power consumption:	4.5 W
Max flow rate:	-
Solenoid valves:	24 Vdc

OplBasic LL

Power supply:	115/208/230 Vac, 50 - 60 Hz
Power consumption:	9 W
Max flow rate:	10 oz/min
Squeeze tube:	SekoFlex

OplBasic DD

Power supply:	115/208/230 Vac, 50 - 60 Hz
Power consumption:	9 W
Solenoid valves:	24 Vdc

OplBasic DL

Power supply:	115/208/230 Vac, 50 - 60 Hz
Power consumption:	9 W
Max flow rate:	10 oz/min
Squeeze tube:	SekoFlex
Solenoid valves:	24 Vdc

OplAdvantage

Multi Washer Systems

OplAdvantage combines SEKO's world leading peristaltic pump technology and guaranteed reliability for accurate dosing in commercial OPL and industrial laundry machines. The OplAdvantage line offers any OPL a perfect solution with a range of dispensers featuring 3 pump sizes with output volumes ranging from 10 to 68 ounces per minute. Innovation allows the system to manage individual dosing formula, assuring high quality performance for up to 9 formulas, each with their own run and delay times.



OplAdvantage LV

Peristaltic dosing systems Low Volume



OplAdvantage SV

Peristaltic dosing systems Standard Volume

Features

- Accepts optional flush manifold and level control device
- Will satisfy the demands of any OPL application
- Squeeze tubing: SekoFlex and SekoBril. Always equipped with inlet-outlet fittings for fast and safe connections (different tubing types are available for specific chemicals)
- Electrical circuit with 6 pump connections
- Front cover opens to 85° allowing easier electrical connections
- Water resistant and durable
- Easy maintenance, no special tools required

Control unit

Complete user friendly programming.

- Easy to install
- Up to 9 wash formulas with manual program activation
- Easy Programming
- 4 different modes Normal, Drain, Relay, Flush
- Access code prevents tampering
- Load count function: stats for each formula
- Up to 75 minutes lock out time
- Second activation level
- Pump calibration function

OplAdvantage

Multi Washer Systems



OplAdvantage SV
Peristaltic dosing systems Standard Volume

Control Unit

Signal Interface Module

Signal Interface Module

- Up to 6 input signals accepted
- Operator safety increased by converting input signal voltage from 20 to 230 Vac to 24 Vdc
- Easy, quick and safe installation with Plug 'n Play cable connections

OplAdvantage LV

Flow rate:	10 oz/min for washers < 65 lbs.
Pumps:	3 - 6
6 Input signals:	20 - 230 Vac
Power supply:	Automatic switching 100 - 240 Vac, 50 - 60 Hz
Power consumption:	30 W max

Wide range of options

- All pumps can be supplied with the option to connect a level probe, an acoustic alarm and a priming switch

OplAdvantage SV

Flow rate:	16 oz/min for washers up < 200 lbs
Pumps:	3 - 6
6 Input signals:	20 - 230 Vac
Power supply:	Automatic switching 100 - 240 Vac, 50 - 60 Hz
Power consumption:	100 W max

OplAdvantage HV

Flow rate:	17 - 68 oz/min for washers > 75 lbs
Pumps:	3 - 6
6 Input signals:	20 - 230 Vac
Power supply:	Automatic switching 100 - 240 Vac, 50 - 60 Hz
Power consumption:	100 W max

OplAdvantage

Accessories



Control Unit Plus

for OplAdvantage

Control Unit Plus provides additional operator benefits, featuring

- 19 Formulas
- Auto formula select



Flush kit

for OplAdvantage

Flush manifold

- Conveniently mounts directly beneath the cabinet
- Injection fittings equipped with built-in check valves. Position is adjustable for ease of tubing installation
- Optional Flow sensor available



Level control and suction devices

for OplAdvantage

- Optional, externally mounted, empty product alert system available
- Fast and safe connections for foot filter and tubing fittings



Solenoid valve

- Plastic cabinet and low voltage power supply
- Check valve between solenoid valve and chemical injection area

OpMini L

Designed for the smallest sites

The OpMini series offers a wide range of compact timed systems to dispense one or two chemicals into small and medium capacity laundry machines. Designed and conceived especially for use in smaller operations with washers with a maximum capacity of 45lbs, OpMini is a digital multifunction peristaltic dosing pump that features SEKO's reknown features and benefits of simple installation, robustness and ease of use.



OpMini L

Multi-function digital peristaltic pump



Remote Control

Accessory with 8 ft. cable

Features

- Precise programming for delay, dosing and lock out times thanks to microprocessor technology
- Motor design and squeeze tube technology provide durability and long life
- NEMA 4X (IP 65) enclosure for optimum water resistance.
- Electrical class 2, no ground wire needed
- Optional push button remote control available

OpMini L

Power supply: 20 - 240 Vac, 50 - 60 Hz

Power consumption: 3.5 W

Dosing Delay Time: 0 - 999 minutes

Dosing Lock-out Time: 0 - 999 minutes

Pressure: max 1.5 psi

Flow rate: 8 oz/min

Squeeze tube: SekoFlex

Wash System Series

Professional Laundry Dosing Systems

The Wash System Series is aimed at the Professional Laundry Industry and has been conceived to allow Professional Laundry Managers to accurately control their overall operation, maximize to reduce over consumption of chemical, water and energy within the overall wash process and therefore manage profits. All Wash System Series products can be equipped with a PoD (Proof of Dosing) system, that ensures precise and steady dosage quantity, regardless of any variability in the condition of the chemical product or feeder tube. Wash System Series also offers the world leading possibility to control the dosing equipment anywhere in the world allowing full remote customer support and program management.



WashMaster

Peristaltic Multi Pump dosing unit, featuring high capacity "HV" pump heads allowing up to 60oz/min flow rate.



WashUltra

Single Pump dosing unit with a Pneumatic Diaphragm Pump offering two flow rates 118 oz/min or 169 oz/min. Comes as standard with the Proof of Dosing (PoD) flowmeter.

Remote management of the dosing systems

Wash System Series can be programmed using a pc, tablet or phone independent of any operating system/hardware. It works in any web browser on any internet enabled device.

No special software is required and it can be used with a PC or Mac Computer, or any smart communication device.

WiFi/Lan direct connection

to allow local programming of the equipment

HTML programming interface

compatible with all internet browsers for any device as PC, tablet and smart device

Features

- Modular system configurable for up to 10 washer extractors, with 16 chemicals and up to 50 formulas
- Parametric dosing of the wash formula based on the washer extractor capacity
- Reliable communication between modules via CANBus
- Wide Range Power Supply 100 to 240 Vac
- Up to 8 inputs for each trigger interface module (SIM) optically insulated 12Vdc 24 to 240 Vac
- Turn Key System
- Quick uploading and downloading of parameters and formulas

Wash System Series

Professional Laundry Dosing Systems

WashMaster

CE Compliant: 100 - 240 Vac, 50 - 60 Hz, 2 Amp

Non-CE Compliant: 90 - 260 Vac, 47 - 440 Hz, 65 W

H Series Pumps

Flow Rate: 1666 ml/min (56.3 oz/min)

Temperature: 68°F (20°C)

Water Supply Specifications

Flow Rate: 0.5 - 2.6 gpm (2 l/min - 10 l/min)

Pressure: 14.5 - 68 psi (1 - 4 bar)

Temperature: 50 - 104°F (10 - 40°C)

WashUltra

CE Compliant: 100 - 240 Vac, 50 - 60 Hz, 2 Amp

Non-CE Compliant: 90 - 260 Vac, 47 - 440 Hz, 65 W

Water Supply Specifications

Flow Rate: 0.5 - 2.6 gpm (2 l/min - 10 l/min)

Pressure: 14.5 - 58 psi (1 - 4 bar)

Temperature: 50 - 104°F (10 - 40°C)

Air Supply Specifications

Flow Rate: 2.6 gpm (10 l/min)

Pressure: 87 - 145 psi (6 - 10 bar)

System components



Trigger Interface Module

Receives trigger signals from each washer and transmits them via a CANbus to the system



Washer Formula Selector

Selects the formula for each washer (Not needed in Autowash mode)

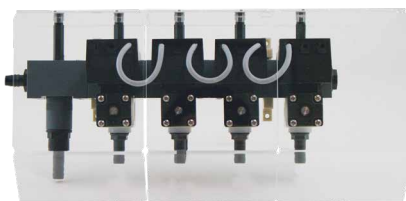

Distributor Module

Allows dosing distribution to each washer extractor using valves that are fully chemical compatible

Accessories



Level Control Module

To monitor the level of chemical containers, up to 8 inputs



Alarm Module

Signal status of the system with flashing light and audio signal



Washer Kit

Extends an already installed configuration

Alpine

Domestic-Style Laundry Dosing

Alpine is for domestic style top load and frontload washers requiring two or three chemicals.

An incredibly cost-effective method to automate domestic style laundry dosing. Its low acquisition cost and fast, easy installation makes it an easy option. Alpine's application flexibility lets you tailor the installation to your requirements.



- Fits manual triggering, remote triggering and automatic triggering applications
- Alpine stores 8 formulas and accepts a 3rd pump
- Low-product alarm eliminates poor laundry results due to empty chemical drums

Smaller operations require less maintenance heavy systems, and Beta Technology's Alpine fits perfectly, with simple operation and great reliability, while the SnapHead™ pump cartridges simplify tube maintenance, preventing chemical burns

Features

- Affordable domestic style laundry dosing
- Minimal inventory requirements
- Low maintenance
- Quick, easy installation

Alpine

Power Configurations: 100 - 240 Vac, 50 - 60 Hz

Tube: Flex, 8 oz, 230 ml/min

Current: 0.42 Amp max (at 240 Vac)

Hydraulic Performance

Maximum Vacuum: 8 in (200 mm) of mercury

Maximum Pressure: 1.4 bar (20 psi)

L5000Plus

Time, Formula, Sequence, Relay & Tunnel Dosing

L5000Plus is Beta's latest innovation in OPL dosing technology. It offers Beta traditional reliability and ease of use but with more versatility. L5000Plus flexibility makes it easy to set up with any washer. It will run up to 3 pumps simultaneously, and each pump can have an independent delay time.

Beta's patented Sequence Mode is great for washers with few or even no signals, and can drive 16 formulas with one trigger. Automatic Formula Selection (AFS) allows you to configure your dispenser to automatically select formulas based on specific trigger timing criteria from the washer. L5000Plus's Dose Verification feature provides an easy "reality check" on the system's calibration.



- Programmer- less Relay Mode and single Formula Mode means a single programmer can be used for several installations
- Allows for up to 8 pumps
- Pump speed control increases tube life with viscous products, reducing service costs
- Programmer can be used to store and copy formulas and formula names for several dispensers
- Computer data interface PCB works with reporting software
- New, more detailed documentation on-line allows for easier installations.
- Automatic Formula Selection (AFS) that makes formula selection more accurate and helps reduce overall equipment costs.
- Dose verification to reduce servicing costs

Features

- New sloped design
- New Trigger Module that can be mounted outside of pump box
- Visible LED on Trigger Module to enhance washer troubleshooting
- TAFS Mode available for tunnel applications
- Automatic Formula Selection (AFS)
- Dose verification

L5000Plus

Power Configurations: 100 - 240 Vac, 50 - 60 Hz

Nominal Flowrate: 500ml/min (16.9 oz/min)

L5000XL

Time, Formula, Sequence, Relay & Tunnel Dosing

L5000XL doses large washer extractors and CBW/ tunnels cost effectively. Can combine up to 8 large or medium pumps and run them simultaneously. Can operate also in programmer-less Smart Relay Mode, and retrofit data logging.

Simplified installation and low maintenance requirements help reduce operating costs. XL features simple volumetric programming, copy and clone functions, easy calibration, Automatic Formula Selection (AFS) and dose verification.



Easy to program, easy to calibrate, fewer trouble calls

- L5000XL has 6 dosing modes: Smart Relay, Formula, Sequence, Latched and TAFS. Automatic Formula Selection (AFS) is available in Latched mode.
- In Continuous Batch Washer applications, all 8 pumps can run simultaneously.
- If remote formula selection is not required, the programmer can be removed after installation is complete.

Clone formulas for quicker installations

L5000XL's cloning ability eliminates repetitive data entry. Storing a master program on a separate programmer, ensures rapid future installations.

Special Features

- Load counts of the 16 formulas are stored, as are alarm counts.
- Trigger diagnostics means you can simultaneously walk around the washer checking wiring while viewing trigger and pump status.
- Counts pump runtime in minutes means product usage calculations and tube life can be tracked.
- XL's alphanumeric formula names eliminate risk of incorrect and costly formula selection simplifying laundry operations and ensuring consistent results.

Features

- Reduces installation and training time
- Reduces maintenance
- PC-software compatibility
- Simplifies formula reconfiguration when replacing other dispensers
- Formula Selector/Programmer features a 16-character alphanumeric LCD display that supports English, Portuguese, French-Canadian, Finnish, Turkish, French, Japanese, German, and Spanish.

L5000XL

Power Configurations: 100 - 240 Vac, 50 - 60 Hz

Nominal Flowrate: 500 - 2000 ml/min (20 - 68 oz/min)

L5000XL

Time, Formula, Sequence, Relay & Tunnel Dosing

Easy to program. Easy to calibrate. Fewer trouble calls.

SmartScreens™ lead you through the programming so quickly, a first time user can program formulas in under 10 minutes.

L5000 XL has 6 dosing modes: Smart Relay, Formula, Sequence, Latched and TAFS. Automatic Formula Selection (AFS) is available in Latched mode. These modes make it tremendously flexible, so the L5000 XL can be installed anywhere. In Continuous Batch Washer applications, all 8 pumps can run simultaneously. If remote formula selection is not required, the programmer can be removed after installation is complete.

Clone formulas for quicker installations

L5000 XL's cloning ability eliminates repetitive data entry. Simply unplug the programmer from a programmed pump box, plug it into an unprogrammed pump box and select "Send." It's easy to edit the downloaded programming. By storing a master program on a separate programmer, all of your installations will be quicker!

Laundries will love you for this

XL allows users to select formulas by name instead of number, so you can throw away those wall charts! Optional low level alarms reduce rewashes. Hygiene verification can be used to verify that wash water temperature meets local regulations. Best of all, operators can either view load counts and pump run times on the programmer, or retrofit a datalogging and communications module that can be combined with ManageNet software to provide full operational reporting.

Easy to calibrate

Our programmer is an ergonomic wonder, fitting in your hand like a TV remote for quick calibrations. You'll never have to calculate a run time again! The calibration is volumetric, so formulas never need to be changed on the washer or in the dispenser to make adjustments for tube wear. Simply recalibrate each pump, and the run times are automatically adjusted! L5000 XL also features dose verification, allowing you to "reality check" pump volumes and recalibrate if necessary.



Ergonomic design makes calibration easy!



WARNING
DO NOT TRY TO OPEN DOOR WHEN
MACHINE IS TURNING
ON
CHECK WATER IN THE WINDOW
IF THE LIGHT IS ON

DO NOT INTERRUPT CYCLE BEFORE DOOR



Surface Cleaning

SEKO's Solutions for Surface Cleaning and Disinfection

SEKO offers the widest range of chemical dilution and dispensing stations, surface cleaning, foaming systems and automated dosing management solutions, suitable across a multitude of applications. Our low pressure systems are especially effective, providing long contact time ensuring an effective, deeper clean. Our ranges offer the trademark SEKO attention to detail for precision, safety, reliability, ease of use and affordability.

Dilution

- Hand pump
- Dilution system

Cleaning and disinfection

- Spraying system

Foaming

- Foaming system

Spraying

- Automotive spraying system

Refill

- Chemical dispensing system

ProMax

Accurate dilution at the push of a button

ProMax features the latest in proportioning technology, reducing flow restriction and maximizing performance even in lower water pressure situations.

It is the latest, most intuitive and cost effective dispensing system available in the market today.

By combining the revolutionary technology of patented hydrodynamics and user friendly, image enhancing features unique to ProMax, SEKO has produced the perfect solution for all institutional and light industrial chemical dilution applications.



ProMax
Button 1 Product

ProMax combines state of the art patented technology with innovative user friendly features

- Modularity for maximum versatility
- Space saving design
- Quick, easy, tool free installation
- Pick up and discharge tubing included for fast easy connection to inlet and outlet fittings

Models available to safely and efficiently fill small, medium and large containers with accurately diluted use solutions from chemical concentrates

- Spray Bottle (1 gpm flow rate)
- Mop Bucket (4 gpm flow rate)
- Floor Scrubber (8 gpm flow rate)

Robust and durable ABS enclosure

- ProMax allows additional units to be easily added to an existing installation
- Wall bracket mounting eliminates need to open enclosure during installation for tool free mounting
- Accurate dilution rates; select from a full range of supplied metering tips

Reliability

Robust materials and construction for maximum reliability:

- Magnetic solenoid type activating valve
- Tamper proof housing and activation mechanism
- 4 product selector valve uses a special seal giving wide ranging chemical compatibility
- Auto-activating venturi requires no downstream restriction to create back pressure
- Patented backflow prevention offers effective protection while minimizing flow restriction

ProMax

Accurate Dilution at the Push of a Button



ProMax
Button 4 Product

ProMax
Button 1 Product

ProMax
Slide 4 Product &
Button 1 Product

Low maintenance

Reduced service calls

- Robust housing and valve activating mechanism
- Robust hydraulic with 130 psi static pressure tolerance
- Auto-locking connection
- Auto-activating venturi
- Optional cartridge filter for poor water conditions to reduce water related service calls

Product range

Flow Rate	Model	Chemical	To Fill	Gap
1 GPM	PX S 1 F 04	1	Slide to fill bottle	FLEX
	PX S 1 A 04	1	Slide to fill bottle	Air
	PX B 1 F 04	1	Button to fill	FLEX
	PX B 1 A 04	1	bucket and bottle	Air
	PX S 4 F 04	4	Slide to fill bottle	FLEX
	PX B 4 F 04	4	Button to fill	FLEX
	PX B 4 A 04	4	bucket and bottle	Air
	4 GPM	PX B 1 F 16	1	Button to fill
PX B 1 A 16		1	bucket and bottle	Air
PX B 4 F 16		4	Button to fill	FLEX
PX B 4 A 16		4	bucket and bottle	Air
8 GPM	PX B 1 F 30	1	Button to fill	FLEX
	PX B 4 F 30	4	bucket and bottle	FLEX

Project your company image

- 95% of the facing available for proprietary graphics using underlays and removable clear faceplates
- No external stick on labels to peel or run from wear or unsightly chemical and water damage
- Customize the facing to identify product and/or establish color coding for employee safety
- Print out small quantities of labels as needed to match your customers' product mix

ProMax

Features

Robust and durable Auto-locking connection
PP enclosure

Cartridge Filter

The optional head filter, enhances filtration where needed in troublesome water conditions reducing service calls.

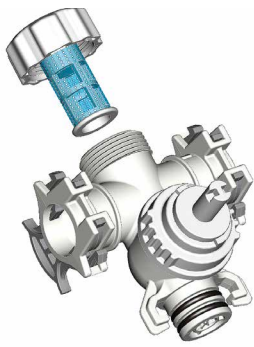

The filtration is independent of the number of units in line.

4 product selector

The newly designed 4 product selector valve has no O rings and is elastomer free. It offers the highest resistance to the widest range of chemicals.

External tip seat

The product suction fittings are located outside, where the tips are also inserted.

- Accurate dilution rates
- Select from a full range of supplied metering tips

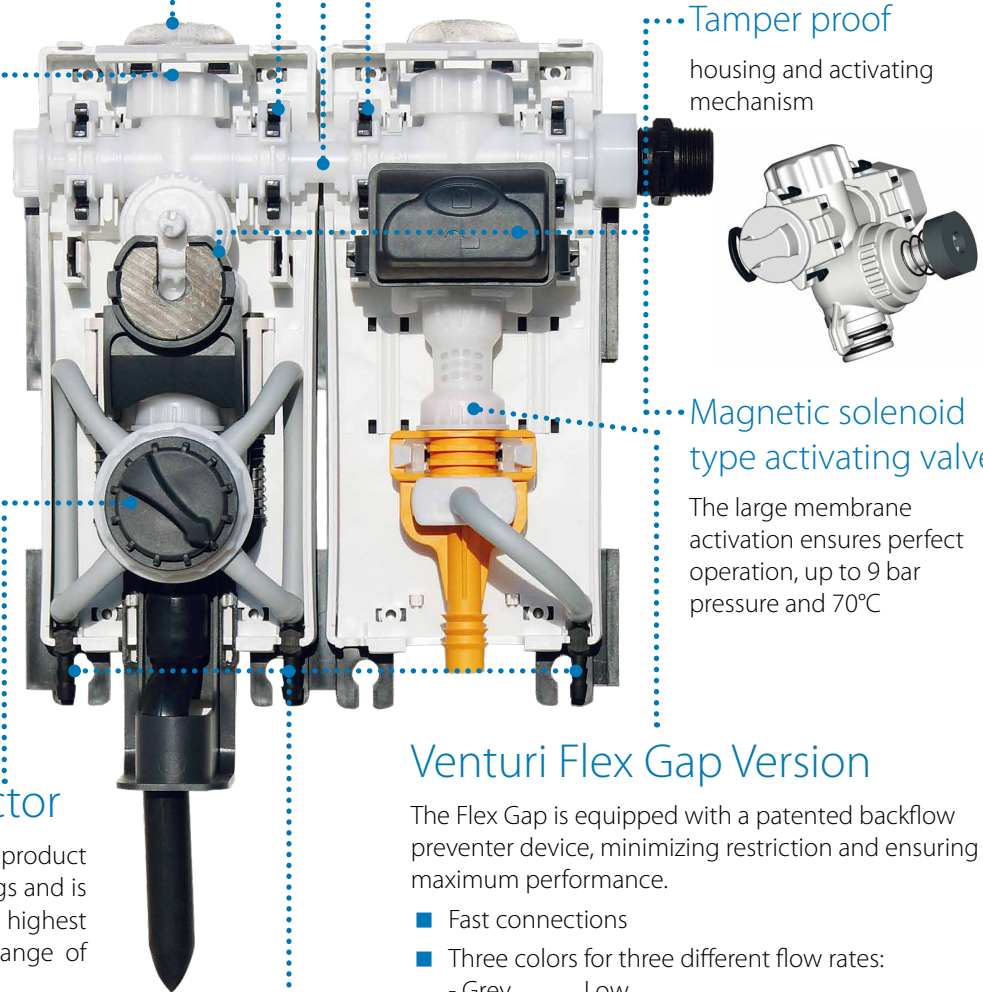

Tamper proof

housing and activating mechanism



Magnetic solenoid type activating valve

The large membrane activation ensures perfect operation, up to 9 bar pressure and 70°C

Venturi Flex Gap Version

The Flex Gap is equipped with a patented backflow preventer device, minimizing restriction and ensuring maximum performance.

- Fast connections
- Three colors for three different flow rates:
 - Grey Low
 - Yellow Medium
 - Blue High
- Same size discharge hose for all models
- Single product units can be easily converted to a 4 product model in the field
- Fully interchangeable parts
- Tool free maintenance

Also available in AIR GAP version

- Two colors for two flow rates
 - Grey Low
 - Yellow Medium

ProDose-R

Push button dosage

Even simple products such as manual warewash detergents and sink sanitizers, can benefit from an accurate and measured consistent dosing mechanism.

ProDose-R represents the latest evolution of the ProDose and features significant enhancements including a flexible spout, larger diameter fittings for highly viscous liquids and improved stroke regulation.



Improved fast stroke regulation

The cap is improved providing ready access to the red adjusting pins while remaining secured during use.



6 different dosage settings

- Ranging from 1/5 oz to 1 oz per stroke
- No need to open the pump to set dosage

Features

- Larger diameter fittings and 3/8" ID tubing improves performance with high viscosity products (>4000Cps)
- Strong, flexible, impact resistant discharge tube
- Made from durable Polypropylene for chemical compatibility to resist breakage
- Fits common standard fittings
- Easy maintenance: unscrew the locknut, remove the fitting, replace the valve
- Double O-Ring Seals. Available in EPDM, FPM or Silicone models to meet various chemical applications
- Valves are the same for left and right
- Easy modular tube stiffeners ensure full evacuation of chemical drums

ProDose-R

Overall Dimensions: H 9" x W 7.25" x D 5.5"

Hose: 10mm ID - 14mm OD

ProSink-R

Accurate dilutions straight to your sink

The ProSink-R is a chemical dispensing system that automatically and consistently mixes the precise amount of detergent and sanitizer with water by turning a knob, conveniently filling large sinks with accurate product solutions.

- Strong, long lasting and easy to clean rugged stainless steel enclosure
- Smooth and ergonomic surface, with no sharp edges and customizable front cover
- Connection direct to the water source, no electric power or compressed air needed
- Space saving
- Quick and easy installation: no special tools required
- Single or Double chemical use
- 4 gpm Flow rate
- Choose from 15 mixing ratios for accurate, effective dosing
- Equipped with an ASSE 1055 certified backflow prevention device UPC and CSA standards
- Fill tube designed to minimize excess foam

ProSink-R F-Gap

Pressure: 22 - 100 psi (1.5 - 6.9 bar)

Gray Venturi

Flow rate: 4 l/min

Dilution Ratio: 2.9:1 - 1000:1

Yellow Venturi

Flow rate: 14 l/min

Dilution Ratio: 5.5:1 - 2000:1

ProSink-R A-Gap

Pressure: 22 - 100psi (1.5 - 6.9 bar)

Gray Venturi

Flow rate: 4 l/min

Dilution Ratio: 3.27:1 - 667:1

Yellow Venturi

Flow rate: 16 l/min

Dilution Ratio: 7.56:1 - 1667:1



Features

- Ball valve operation
- No need to hold or lock a button
- Smooth and ergonomic surface and customizable front cover
- Rugged stainless steel enclosure
- Strong, long lasting and easy to clean
- Installs easily with 2 or 3 screws
- "Quick connect" manifold to insure fast easy maintenance
- Direct connection to water supply
- No electric power or compressed air needed
- Integrated backflow prevention

ProFaucet

Makes your tap count

The ProFaucet is a new and easy faucet proportioner for mixing pot & pan chemicals with water in the desired ratio at the push of a button.

Simple to use

With the water on, push the button and release it. The system mixes the chemical into the flow in the desired ratio. When water is turned off the button automatically releases to provide fresh water when the faucet is reactivated.

Compact and easy to install:

- Remove the faucet aerator
- Screw the ProFaucet onto the threaded outlet
- Connect the chemical

ProFaucet's full stainless steel body is made to withstand heavy use and chemical aggression for reliability and long life. The modern design provides an enhanced image. Consistent performance makes it suitable for most any pot & pan application.



ProFaucet

Performance	Pressure	Dilution Ratio	Flow-rate
Max	85 psi	290 : 1	4.5 gpm
Max	22 psi	5.7 : 1	4.5 gpm

Features

- With minimum investment the ProFaucet provides excellent chemical consumption and cost control.
- No more manual mixing to eliminate unnecessary direct contact with concentrated chemicals.
- By eliminated manual dosing, the ProFaucet reduces the possibility of over use of chemical and excessive use cost
- Quality, Stainless steel body
- Chemical & impact resistant
- Updated, modern design
- Easy to install and to use
- Accurate, reliable
- Durable, convenient

ProSpray

Spray system at the flick of a switch

The ProSpray cleaning and sanitation system automatically dilutes and dispenses concentrated cleaning products as a foam or spray. The spray system is easily and quickly converted into a foam system with the “quick-coupling” foam wand.

- Strong, long lasting and easy to clean rugged stainless steel enclosure
- Smooth and ergonomic surface, with no sharp edges
- Connection direct to the water source, no electric power or compressed air needed
- Space saving
- Quick and easy installation: no special tools required
- 2 product dosing in succession or simultaneously
- Single or multiple chemical use
- 3.5 gpm Flow rate
- 15 different mixing ratios can be easily chosen, making the dosing accurate and effective
- Fill tube designed to minimize excess foam

ProSpray

Flow rate: 1.79 - 3.30 gpm

Pressure: 11.6 - 40.61 psi



Features

- No “Lock-Tite” threaded connections
- Simple maintenance thanks to “quick connect” manifold
- Non return valve and metering tips are easily accessible
- Brass fittings for hot water resistance, polypropylene injectors for chemical resistance, rugged stainlesssteel casing for secure mounting and durability.
- Suitable for use in food processing, dairy, transportation, industrial and agricultural industries.
- It can also be used: in supermarket meat rooms, seafood shops, butcher shops, automotive care areas, shower rooms

JetNeat

Portable dilution in your hand

The JetNeat system, the fastest, easiest, most convenient and suitable solution to wash, sanitize and rinse surfaces.

JetNeat is composed from a spray gun with a quick connector and a venturi with a chemical tank built-in which can be applied at the exit of it.

Connected to the water tap by a flexible hose, the trigger gun is able to rinse thanks to a fresh water powerful jet.

Once the venturi is quick applied at the outlet of the gun, the JetNeat can produce a mixing solution that can be sprayed or foamed based on the model and chemical used.

Fits the need

JetNeat is a suitable solution for a variety of applications, and by combining the various elements, an ideal solution can always be found.

- Wet room
- Shower facility
- Kitchen
- Butcher shop
- Restaurants
- Supermarkets
- Health care
- Educational facilities
- Animal care

Features

- Chemical tank made in PP for chemical and physical damage resistance
- Light weight gun easy to use with brass nickel plated connector
- Strong PP body with built in venturi and brass nickel plated connection



JetNeat
0.7 Gallon



JetNeat
0.4 Gallon

JetNeat

Max Pressure: 83 psi (6 bar)

Min Pressure: 25 psi (1.8 bar)

Max Temperature: 104°F / 40°C

ProTwin

Two in One Foaming Solution

SEKO's ProTwin and ProTwin Foam systems are ideal for large food preparation areas and are suitable for the retail, institutional and healthcare markets. Featuring an ergonomic design that is HACCP compliant ProTwin automatically mixes and dispenses concentrated chemicals through its spray gun which features an adjustable spray pattern delivering high levels of wet foam.

Its central dial selector makes switching between Rinse & Sanitize functions easy even with wet gloves. The ProTwin optional kit provides unsurpassed dry foam performance, making cleaning high level vertical or difficult surfaces easy. The powerful jet provides foam at up to 4 meters in height.



Features

- Adjustable spray pattern
- Separate selectable chemical position eliminate risk of chemical crossover
- Unsurpassed foam quality
- Engineered eductors ensure accurate, proportionate dosing
- Intuitive ergonomic design for user friendly operation
- Single spray gun for foam, rinse & sanitizing
- 3 functions spray/foam and rinse up to 140°F (60°C) tolerance

ProTwin

Performance	Pressure	Dilution Ratio	Flow-rate
Max	85 psi	6.5 : 1	(Rinse) 4.5 gpm
Max	85 psi	1429 : 1	(Prod) 4.5 gpm

Adjustable spray pattern & thick foam all in one

Without Foam wand



Without Foam wand



Foam Wand

Light – durable spray gun

With Foam wand



ProTwin Foam Kit

Two in One Foaming Solution

ProTwin foam kit

- Utilizes the ProTwin's single selector for detergent and sanitizing functions
- Generates surface clinging dry foam for maximum contact time
- ProTwin's venturi maintain a proper and consistent chemical action/consumption
- Excellent for vertical surface cleaning
- Enhances the properties of foaming chemicals with the use of compressed air



ProTwin Foam Kit

Features	Flow-rate	Dilution Ratio	Pressure
Rinse	2.5 gpm	-	max 85 psi min 15 psi
Foam	1 gpm	max 6:1 min 116:1	max 85 psi min 15 psi
Product	1.9 gpm	max 20:1 min 339:1	max 85 psi min 15 psi



With ProTwin Foam Kit



SekureMax

Simple and safe chemical storage

SekureMax is an evolutionary chemical dispensing cabinet incorporating many innovative features designed to assist management in chemical use and storage.

SekureMax has been designed to ensure the best compromise between accessibility and its total footprint while remaining easy to clean.

Furthermore it is flexible enough to hold multiple sizes of chemical container covering 5lt, 2 x 2lt, 3 x 1lt and even 1 gallon jug.

SekureMax comes with the ability to lock the cabinet door using a revolving plug or universal plastic key, guaranteeing the appropriate level of security.



SekureMax

Dimensions: H 14.3" x W 8.9" x D 6.9"

Features

- Semi flat pack, folding design helps drive cost savings during shipment and reduces space required for stock holding
- Robust ABS lockable cabinet incorporates the dispenser and provides space for variable sizes of chemical container
- Customizable front panel cover to assist in promoting safe communication of the chemical content or for Customer Brand promotion
- The mounting bracket system provides superior modularity and compatibility with the ProMax and SekureDose ranges as well as ease of installation
- Smart design that remains easy to clean
- Lockable with revolving plug or universal plastic key

SekureMax

Simple and safe chemical dosing

Foldable

Enjoy the advantage of reduced shipping costs and reduce stock space



Modularity

Ultimate flexibility and modularity of the system allows exact site specific installations for maximum efficiency

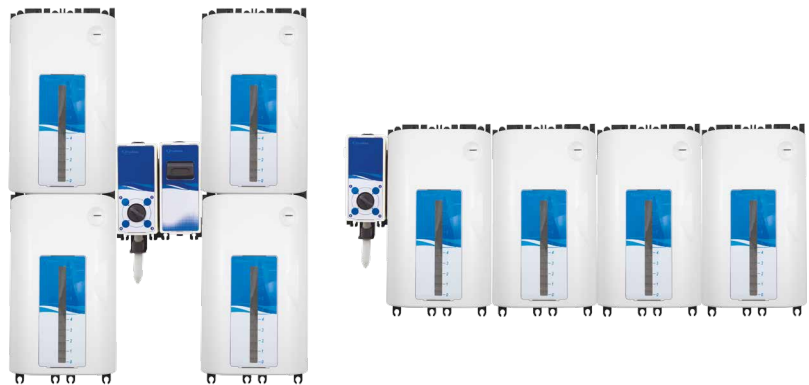

Custom solutions

Promote your own or customer's brand or use the custom options to focus on health and safety and correct product usage. Clean, simple design ensures SekureMax can always be kept clean providing the right image



SekureDose

Simple and safe chemical dosing

SekureDose is simply the safest and most convenient "all in one" system for dosing chemicals in places like hotels, restaurants, schools and offices.

SekureDose is the ideal "turn-key" solution for filling spray bottles or buckets to wash floors, counter tops or other hard washable surfaces and for sink filling for pot and pan washing.

SekureDose offers tool free installation and with an easy to maintain manual pump mechanism built into a robust, easy to clean chemical cabinet.

- Easy calibration
- No electrical connection, no water supply required
- Modular flexibility

Features

- Turn-key solution
- Lock out mechanism to avoid over consumption
- Tool free installation and maintenance
- Robust ABS lockable cabinet includes the dispenser and variable sizes of chemical packaging
- System can be extended using additional units for multiple product dosing
- Flexible shockproof spout
- Variable stroke rates available through pin selection
- No contact between the spring and chemical. Available as standard with EPDM seal: optionally available with FPM or Silicone.
- Three versions available: sink, bucket and bottle filling – with variable height bottle tray.

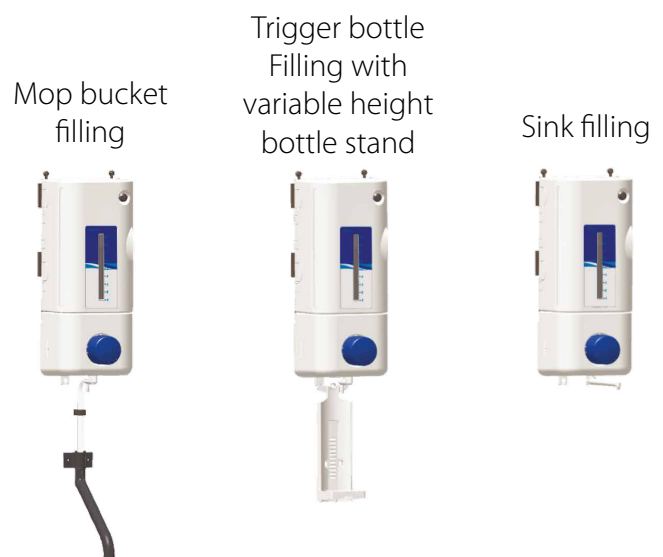

SekureDose

Body Unit: H 21" x W 8.9" x D 7.8"

Sink Unit: H 20.8" x W 8.9" x D 12.5"

Trigger Bottle: H 32.6" x W 8.9" x D 7.8"

Bucket Nozzle: H 11.5" x D 10"

SekureDose

Simple and safe chemical dosing

Easy installation

Just fix to the wall, insert the chemical container and start to use



Custom solutions

- Possibility to lock the cabinet either with a revolving plug or with a universal plastic key
- Wide customization capacity: coloured caps and custom labels to make SekureDose even easier and intuitive for the end user



Easy modular tube stiffener

Ensures the feed tube pulls from the bottom of the chemical container minimising waste and delivery issues

Improved check valves

- Easy maintenance: unscrew the locknut, remove the fitting, replace the valve
- Double O-ring seals
- Valves are the same for top and bottom side

Fast stroke regulation

The large cap provides easy access to the stroke regulating pins whilst remaining secure during use



6 different dosage settings

ranging from 5cc to 30cc per stroke



BetaJet

Venturi-Based Proportioning System

BetaJet's patented design makes offers reliability and convenience unlike any other proportioning system. Installation is easy and reduces the need for unscheduled maintenance caused by the clogging of old-fashioned metering tip and are also reduced by BetaJet's ultrafine filtration water strainer.

BetaJet also reduces inventory requirements with a simple reconfiguration. Switching from bottle fill to bucket fill is fast and additional units can quickly fix together without tools or threaded fittings.

Features

- Attractive design
- Easy installation
- Reduced trouble calls
- Simple maintenance
- Increased safety

Reducing costs

- Fast dilution adjustments with patented metering peg
- "Tool Free" assembly
- Threadless, quick connectors for multiple product systems
- Fast and easy disassembly and reassembly for routine maintenance
- Unit can be customized in the field

Innovation drives satisfaction

- Patented clog-resistant metering peg is easier to handle and harder to lose
- Ultra-fine mesh strainer that protects nozzle from splash-inducing debris
- Flow-through strainer reduces clogging
- R-Gap provides extreme reliability, even with extremely hard water
- A-Gap nozzle features patented lip that reduces scale-induced backpressure splashing
- Patented laminar-flow eductor body reduces splashing
- Easy "Push-on, Push-off" latching



BetaJet

Venturi-Based Proportioning System

Clog resistant, flow-through strainer. Water flows around it on multiple unit systems, so even if the first one clogs those down-stream aren't effected.

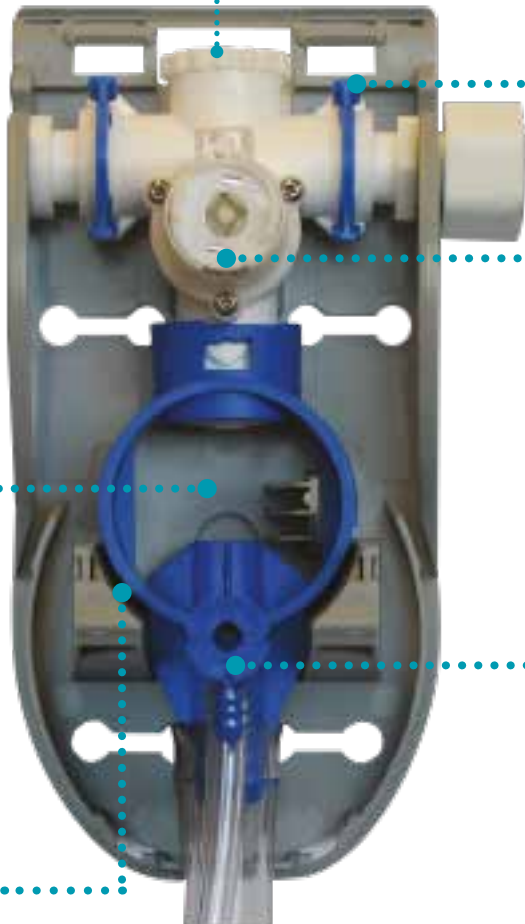

E-Z on "Blue Clip" simplifies water connections

Valve is easily changed from latching to non-latching; just twist the disc

A-Gap and R-Gap are ANSI/ASSE 1055B and UPC approved for backflow protection

Adjust dilution without removing chemical tube

Value/Venturi assembly snaps into backplate

BetaJet

Dilution Range:	Low Flow: 3:1 - 525:1
	High Flow: 5:1 - 800:1
Ext. Dilution Range:	Low Flow: max 800:1
	High Flow: max 1200:1
Pressure A-Gap:	Low Flow: 14 - 78 psi (1 - 5.5 bar)
Pressure A-Gap:	High Flow: 14 - 78 psi (1 - 5.5 bar)
Pressure R-Gap:	All: 28 - 78 psi (2 - 5.5 bar)
Dimensions:	H 8" x W 3.9" x D 3.75"
Nominal Fill Rate:	Low Flow: 1 gpm/4 l/min at 40 psi/2.67 bar
	High Flow: 3 gpm/11 l/min at 40 psi/2.67 bar

Water flow around filter to other proportioners

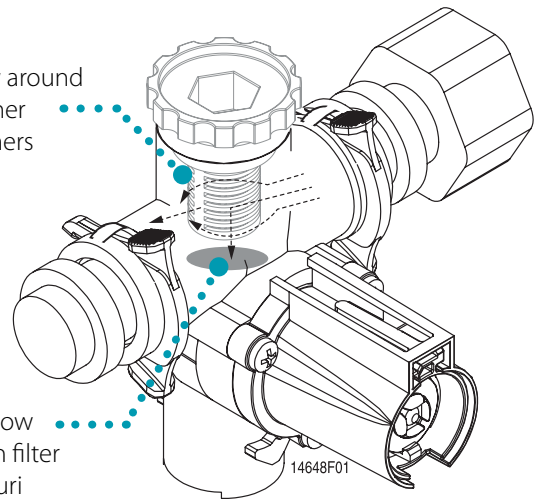

Water flow through filter to venturi





Beta TECHNOLOGY

Specialty

A Beta System for Every Customer

Beta Technology is world known for its design and know how in the dosing and dispensing for janitorial, catering and laundry sectors, but they have also taken this know-how into areas that are more diverse.

Applications

- Swimming Pools
- Spa

Pool Shot

Recycle-Timer or Controller-Activated Pump

PoolShot is a microprocessor-controlled, repeating event chemical injection pump for accurate dosing in a variety of applications involving large bodies of water such as pools, spas, fountains and ponds.

PoolShot features:

- Programmable delay, dose and lockout times.
- Delay and dose time ranges: 1 sec to 19m 59s
- Lockout and delay times combined: 1 sec to 39m 58s.

PoolShot can be triggered from an external controller, power connections (115 to 230 Vac), a contact closure or from an external voltage signal from 24 to 240 Vac to Vdc using an optocoupler.

PoolShot can handle chlorination for pools up to 100,000 gallons. For larger pools or load issues use either one or two PoolShots to establish a baseline of regular chemical addition, adding a Pool-2000 to inject booster doses during times of high bather load or sunshine.

Features

- Buttons and liquid crystal display allow quick digital programming
- Water and sunshine-resistant enclosure
- Standard tube out-performs competitor's tubes and handles all pool chemicals: chlorine, acid, algaecide, clarifiers, etc.
- Repeat cycles
- Programming with a 10-minute runtime and a 1-second delay allows this dispenser to be used as a "slave" pump to an ORP pH controller



PoolShot

Power Configurations: 115 Vac, 50 - 60 Hz

Pump: Peristaltic, self-priming, self-checking 6 volt DC

Flow Rate: 14 gpd / 53 l/d

Pressure: 30 psi / 2.07 bar

Pool 2000

Programmable, Automatic Weekly Clock-Based Pump

Pool 2000 is a microprocessor-controlled, clock-based chemical injection pump for accurate dosing in a variety of applications involving large bodies of water such as pools, spas, fountains and ponds.

Pool-2000 has a real-time clock, and keeps track of which day of the week it is, so it can dose daily during certain times of the day, and is programmable for independent dates/times. [i.e. 7 day clock, 1 event per hour and all events can be different, absent or programmed to be the same].

Pool 2000 also features:

- Easy-to-read liquid crystal display screen and buttons
- Programmable run time 1 sec to 19m 59s each hour.
- Memory-backup battery
- Rugged water and UV-resistant enclosure for external mounting.

Pool Shot doses on a recycle timer, turning on and off in a continuous cycle to establish a baseline of regular chemical addition. Pool 2000 can be used to inject booster amounts during times of higher bather load or sunshine.



Pool 2000

Power Configurations: 115 - 230 Vac, 50 - 60 Hz

Squeeze Tube Output: 2.5 oz (0.124" ID "Sanitizer" tube: 9.28 gpd/35.13 l/m, up to 30 psi (2.07 bar))

Pump: Peristaltic, self-priming, self-checking 6 volt DC

Features

- Easy setup, programming and maintenance means you spend less time in the field
- Cost-effective, even for low-volume operation
- Standard tube handles all pool chemicals: chlorine, acid, algaecide, clarifiers, etc.



Your Choice, Our Commitment

People choose to do business with SEKO for one or more reasons, but ultimately it is their choice, and therefore they merit our commitment. "Our commitment" is total and not only to our customers, but also to each other and the Company's to its employees.

Vision

**TO BE YOUR PARTNER OF CHOICE FOR
DOSING SOLUTIONS, GLOBALLY**

SEKO, is a passionate, dedicated Global Family of Professionals. We listen to each of our Partners and are committed to deliver the right solution in the Hygiene, Water Treatment and Industrial Process markets.

Values

**MUTUAL RESPECT, QUALITY AND
SPIRIT OF COLLABORATION**

MUTUAL RESPECT

Mutual Respect because doing business is about being able to generate trust between Customer and Supplier. We'll deliver against our commitments, on time and in a transparent fashion, so you know can plan for your own business needs.

QUALITY

Quality for SEKO is a 360° reality. It covers not only the design, development, production and delivery of our products and solutions but it runs through the core professionalism of our teams.

SPIRIT OF COLLABORATION

Spirit of Collaboration is fundamental to our success and SEKO prides itself on how we work as a worldwide team, blending multiple country teams and functions to bring solutions to a Customer request or market need from an idea to the real world in very short time, across our global presence and beyond.



Your Choice, Our Commitment

In the modern Globalised world, being a privately owned Company has significant benefits especially for our Customers, our Partners. For over 40 years, SEKO has developed a Global organisation able to take the longer view, manage the pressure of the now, and to plan for the long term, delivering true Partnership for our Customers, with transparency and mutual respect for each other.

Whether it's for our reknown flexibility, our attention to detail, the high-quality products, or just the way we do business, we understand that it's Your Choice to do business with us. It is Our Commitment to fulfill your needs wherever you, our Customers are.



For more information about our portfolio, worldwide locations, approvals, certifications, and local representatives, please visit www.sekousa.com

As part of a process of on-going product development, SEKO reserves the right to amend and change specifications without prior notice. Published data may be subject to change.

© SEKO, Layout and origin: UK, 850003-CHG_en, 05.2017

The SEKO logo is positioned at the bottom right of the page. It features the word "seko" in a bold, lowercase, sans-serif font. The letters are a vibrant blue color, matching the overall theme of the advertisement. The 's' and 'e' are connected, and the 'k' and 'o' are also connected, giving it a cohesive, modern look.